

Easy, on-site measurements by anyone

BENCH-TOP COORDINATE MEASURING MACHINE



Measurement when you need it, where you need it

YOUR PERSONAL COORDINATE MEASURING MACHINE



Handheld Probe Coordinate
Measuring Machine
XM Series

1

ALL-IN-ONE CONCEPT
**On-site
measurements**



2

HANDHELD PROBE
**Easy to handle with
no restrictions**



3

PROBE CAMERA
**See what you
measure**

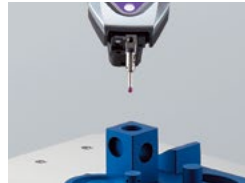

4

X θ STAGE
Easy operation



5

SIMPLE INTERFACE
Easy to understand

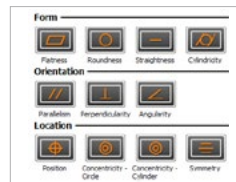

Bench-top coordinate measur offering on-site measurement immediately after power-up

The XM Series features immediate launch ca
power supply. Achieve high-precision coordinate
sacrificing space. When it comes to meeting such
immediate measurement and reductions in measu
also improving productivity, KEYENCE's XM Series
measuring machine is the answer.



Ultra-robust camera

15" LCD monitor

Stage marker

uring machine nts

capabilities with a single
e measurements without
worksite requests as
ement wait times while
s bench-top coordinate

Position detection technology that bolsters precision



The XM Series adopts a new principle that includes the camera capturing the near-infrared light emitted from seven different markers. Thanks to about 100 LEDs on the coordinate measuring machine probe and nano-order surface processing, users can achieve repeatability of $\pm 3 \mu\text{m}$ despite manual operation.

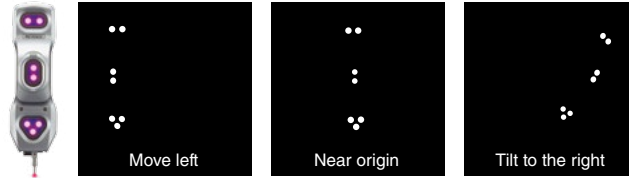

[Probe information captured by the ultra-robust camera]
Using the coordinate data from each marker, the machine is able to determine the position and orientation of the probe.



Wide field of view for catching probe marker positions



The camera on the XM Series is tasked only with capturing the near-infrared light emitted from the markers. So long as the probe is within the camera's field of view, the machine can detect the probe's spatial position and orientation.

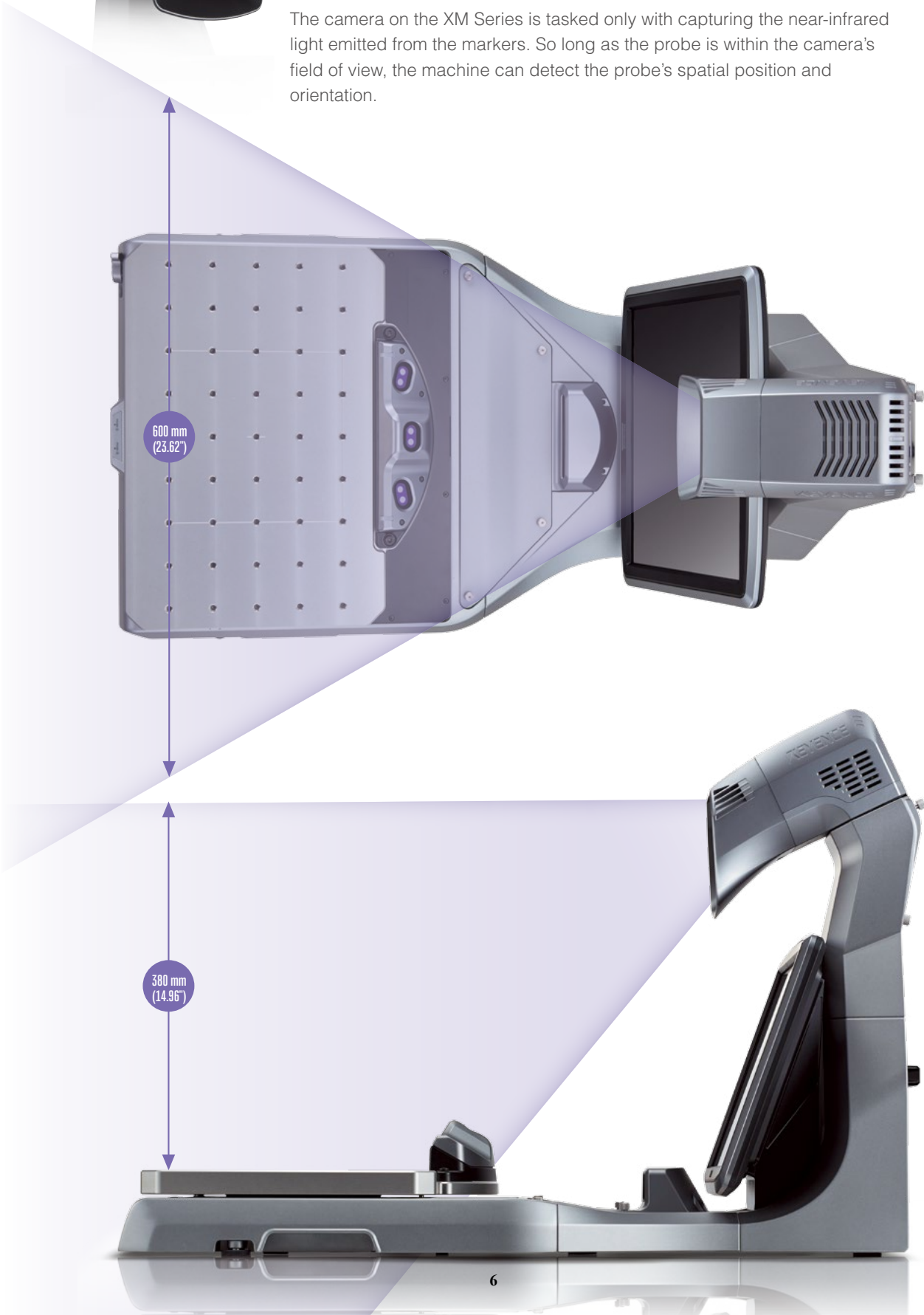

Measurement of targeted locations with no routing limitations



So long as the probe is within the camera's field of view, measurement locations can be approached from any angle. With the XM Series, users don't need to worry about changing the orientation of the stylus for every measurement location, and calibration after replacing the stylus is not necessary.

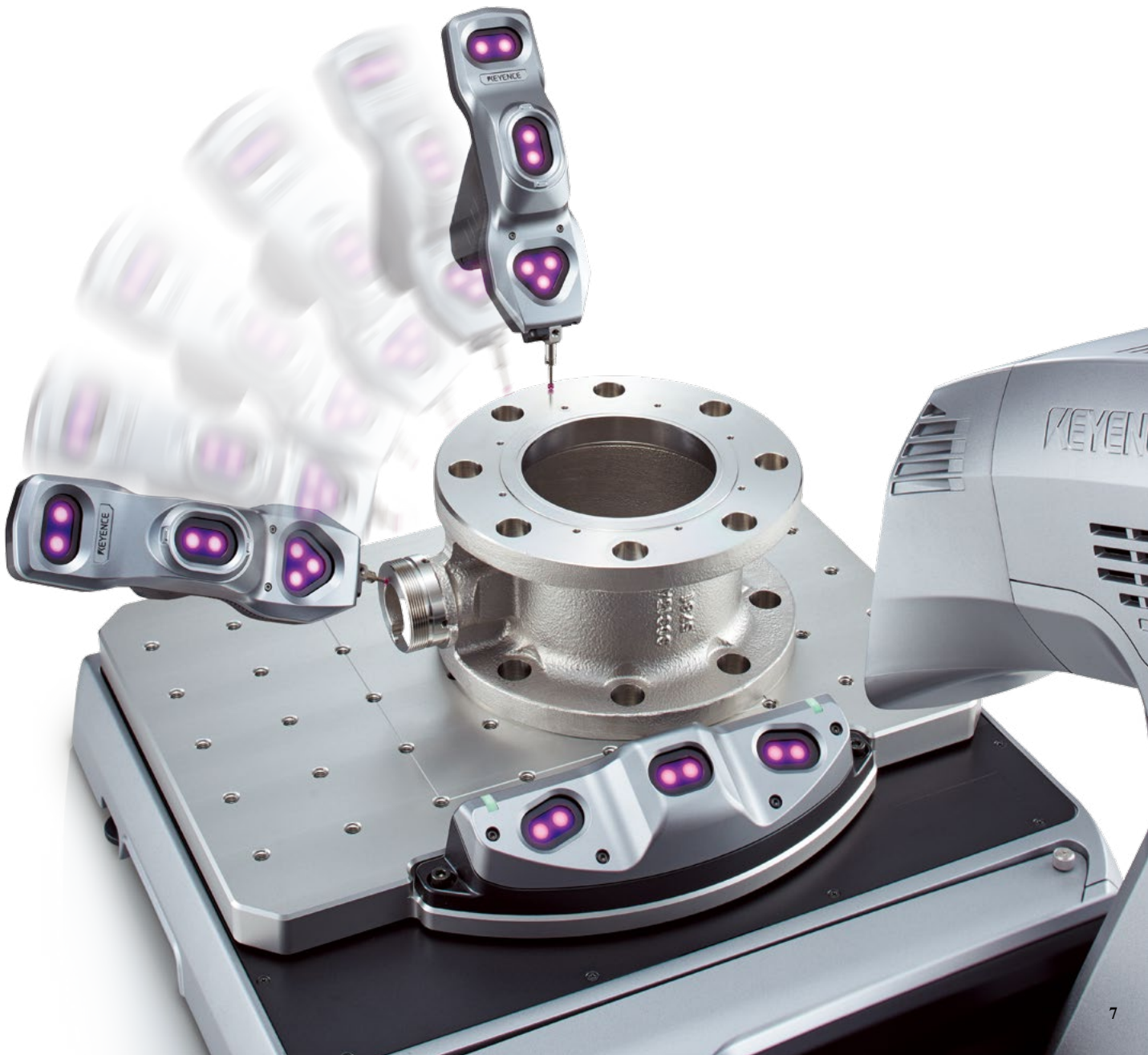

All-in-one design that allows for instant measurement at the desired location



Compact, bench-top design allows measurements to be performed closer to the worksite

The compact design of the XM Series allows the machine to be placed in a variety of locations including; on worksite measurement tables, next to processing machines, or even in an office. This makes it possible to not only reduce the effort needed for carrying measurement targets to a measurement chamber but also eliminate measurement wait times.



At worksites

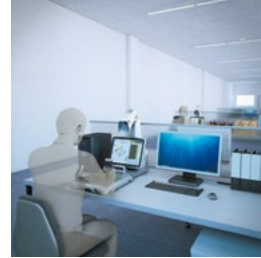

In offices

No measurement chamber required (Operating environment: 10 to 35°C 50 to 95°F, 20 to 80% RH)

The probe used in the XM Series features quartz glass. The lens and lens tube of the camera employ a unique design that reduces the influence of temperature fluctuations. In addition, data from the internal temperature sensor is used for correcting any changes due to temperature within the housing itself. Moreover, unlike conventional coordinate measuring machines, the construction of the XM Series includes no movable parts such as arms or bridges, providing maintenance-free usability with no environmental influences such as temperature and vibration.



Probe internals (quartz glass)



Unique lens and lens tube design

Highly rigid body with strong resistance to external vibrations for stable measurement even at manufacturing worksites

With coordinate measurements, changes in the position of the measuring machine and the measurement target due to vibrations can lead to measurement errors. With the XM Series, the frame offers high stiffness thanks to unique equipment design technology in order to allow measurements to be performed even in locations that are problematic for conventional coordinate measuring machines, such as next to processing machines at manufacturing sites or on the second floor of a building.

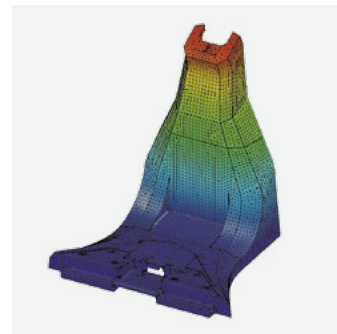

Approach measurements from any angle thanks to state-of-the-art technology with single-handed operability

Increased visibility from the camera for high-precision measurements

Probe marker position

Offering the horizontal, vertical, and triangle markers and arranging height differences, the XM Series offers enhanced visibility from the ultra-robust camera for further improved measurement accuracy and stability.

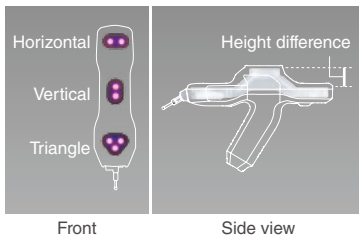

Detection status confirmation LED



Measurement possible



Prevent damage and measurement errors caused by contact pressure

All-in-one structure

The integrated construction reduces measurement errors while the cushion structure allows for a high level of damage prevention during contact.

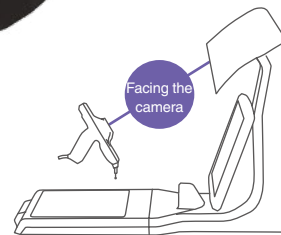









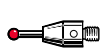

The probe directly faces the camera.

Ergonomically designed grip

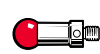
The XM Series is designed so that the probe faces the camera straight on when the stylus is positioned directly underneath. Additionally, the probe itself is made with oil-resistant PBT plastic, which allows measurements to be performed even in the worksite.

Changing the stylus opens the door to a variety of measurements

▼ LIST OF RECOMMENDED STYLUSES

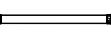
Component number	A-5003-1325	A-5003-2932	A-5003-0054	A-5003-4793	A-5000-6731	A-5000-7555	A-5000-7557
Shaft material	Carbide	Carbide	Carbide	Carbide	Steel	Steel	Steel
Sphere diameter (mm inch)	ø1 ø0.04*	ø2 ø0.08*	ø2.5 ø0.10*	ø3 ø0.12*	ø5 ø0.20*	ø6 ø0.24*	ø8 ø0.31*
Length (mm inch)	10.0 0.39*	20.0 0.79*	20.2 0.80*	20.0 0.79*	20.0 0.79*	17.0 0.67*	16.0 0.63*
Stylus	 Screw diameter conversion adapter A-5004-7595 required		 Screw diameter conversion adapter A-5004-7597 required				
Component number	A-5004-7599	A-5004-7600	A-5004-7601	A-5004-7602	A-5000-7754	A-5000-7755	A-5000-7727
Material	Steel	Steel	Steel	Steel	Ceramic	Ceramic	Ceramic
Length (mm inch)	10.0 0.39*	15.0 0.59*	20.0 0.79*	30.0 1.18*	30.0 1.18*	50.0 1.97*	100.0 3.94*
Shaft diameter (mm inch)	7.0 0.28*	7.0 0.28*	7.0 0.28*	7.0 0.28*	7.4 0.29*	7.4 0.29*	7.4 0.29*
Extension							

Styluses other than the standard stylus or the ø2 mm ø0.08 stylus can be purchased from Renishaw plc.

Greater freedom of approach thanks to the ability to change orientation of the stylus

In order to better suit the measurement location, the mounting angle of the stylus can be changed as desired.

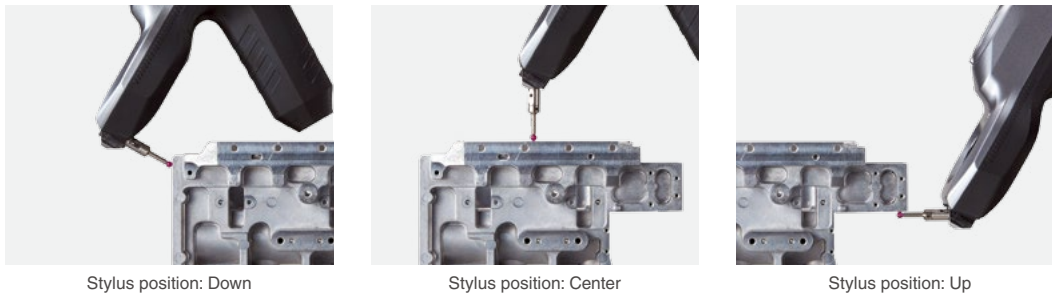

Connecting two probes simultaneously further improves usability

Use the pull-down menu on the screen to quickly switch between probes. Attaching a different stylus with a frequently used diameter and length to an additional probe in advance allows users to eliminate the hassle of replacing the stylus during measurement. The detection status notification LED will illuminate to notify users which probe is currently selected.

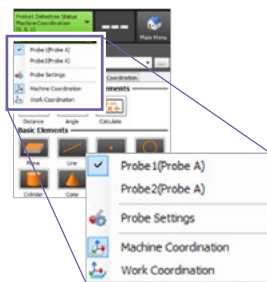

Easy probe selection

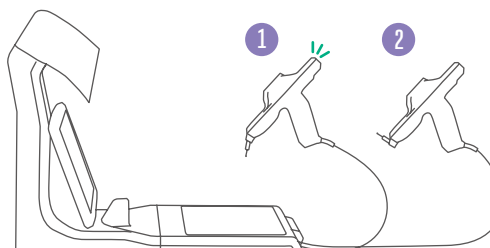

A compact camera makes coordinate measurements easy to understand by displaying the external appearance with measurement details and values

Displays that show only the rendered area or that show only the elements, such as "Circle 001", can be difficult to understand for those who are not familiar with them. The XM Series, however, includes a small camera at the probe tip that is capable of displaying not only the external appearance of the target but also a description of the measurement and the measured value, significantly bolstering coordinate measurement accuracy.



Probe camera

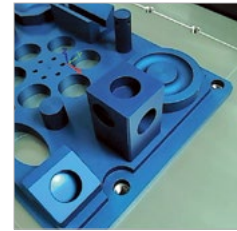

Probe camera video



Augmented Reality shows what you measure

For every measurement point, the XM Series displays the element name and number as well as the measurement results in real time. The measurement range for each element is also displayed, allowing users to see at a glance which section was measured.

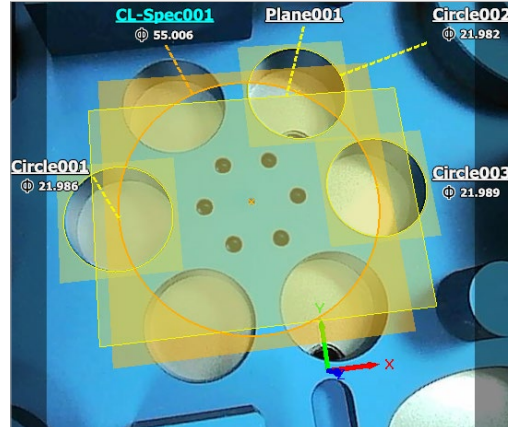

Easy creation of viewer-friendly reports complete with images

Reports including images can be prepared automatically as a standard function. Measurement points and items are laid out automatically, resulting in significant reduction in Inspection report and operating instruction preparation time.



Search for configuration files using 2D codes printed on reports

Using the XM Series, users can capture 2D codes on reports to search for and open their corresponding guided measurement files.

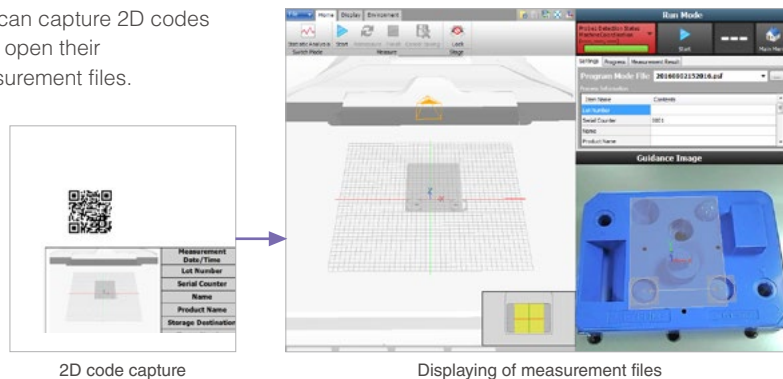

High-rigidity Xθ stage for further enhanced measurement range and ease of use



Enabling high-accuracy position measurement:

Stage marker

The markers incorporated on the stage make it possible to recognize the amount and inclination associated with the movement of the Xθ stage with high precision. Measurement of long targets and targets with measurement points that are outside the camera's field of view can be measured by moving the measurement points inside the field of view.



Wide measurement range in a compact body

The ability to move the stage up to 100 mm 3.94° to the right or left allows for a measurement range twice that of conventional models, making it possible for users to perform measurement from a position with a clear view of the camera.

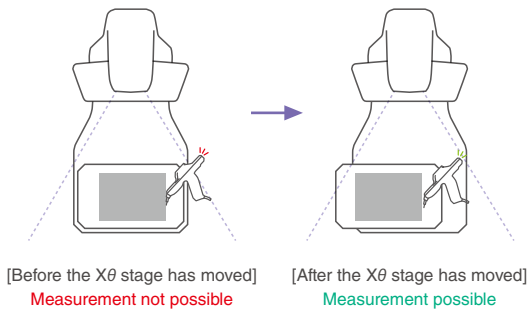

Move the stage to keep the probe within the field of view.

Rotatable stage for improved measurability

The stage can be rotated up to 60° to the right and left in the θ direction to allow for even more measurement locations while keeping the stylus orientation fixed.

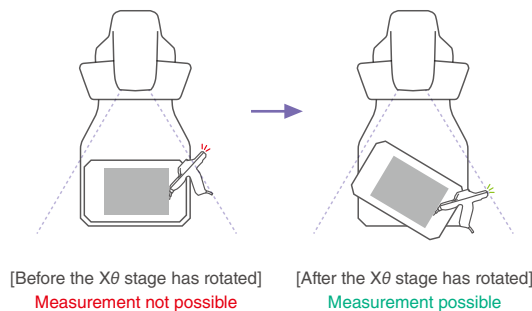

Rotate the stage to keep the probe within the field of view.

Smooth movement for an exquisite feeling of operation

The XM Series adopts a low center of gravity design that includes a θ mechanism between high-rigidity shafts. With an installation area virtually unchanged from conventional models, the XM Series makes it possible to perform an even wider range of measurements.

In addition, even if the weight of the measurement target changes, the sense of weight feels the same thanks to a "Gentle mechanism". Due to these features, the XM Series is able to provide users an experience free of operational stress.



The high-rigidity stage can withstand loads up to 25 kg.

SIMPLE USER INTERFACE THAT FACILITATES MEASUREMENT EVEN FOR FIRST-TIME USERS

When it comes to coordinate measuring machine interfaces, an image of difficult and inorganic commands comes to mind. With the XM Series, however, users get a friendly level of operability through images, colorful icons, operation instructions using videos, and more.



Interchangeable element tree

Measured elements can be easily modified and re-ordered using the interchangeable element tree.

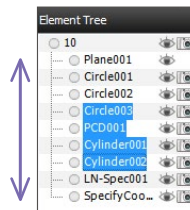

Measurement point details display

GD&T and coordinate data for each element is calculated at the same time. The deviations for each measurement point can also be displayed.

Measurement Result		Measurement Point			
No	Deviation	M1 Coord.	M2 Coord.	M3 Coord.	M4 Coord.
1	0.002	-69.788	-39.804		9.133
2	-0.001	-71.886	-8.875		9.627
3	-0.002	-45.253	-16.462		9.415
4	0.001	-66.942	-41.047		16.283
5	0.002	-72.893	-6.739		15.796

Switch between the rendered area display with convenient scaling or the camera image display

With the XM Series, users can easily enlarge or shrink the rendered area. This allows for smooth verification of measurement points and for simple confirmation of obtained measurement data. In addition, users can also view the image from the camera in order to check data on an actual image.

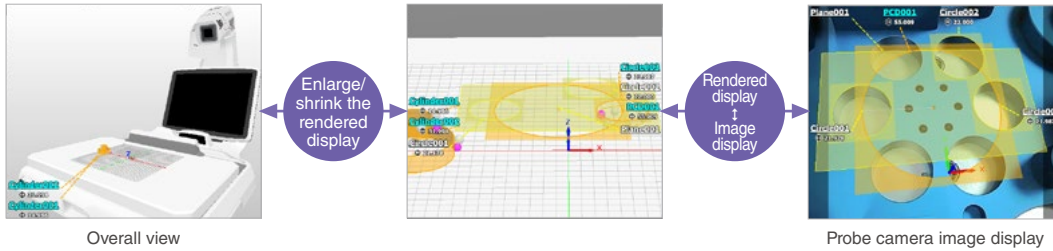

Easy-to-understand basic measurement menu

Basic measurement elements that are frequently measured—such as Plane, Line, Point, Circle, Cylinder, Cone, and Sphere—are collected on a single sheet. A video describing the operation for each element is also provided.

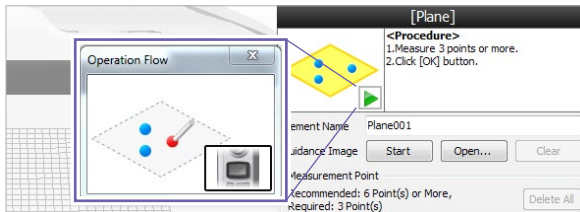

Clicking the green "▶" on the screen will bring up a window showing a video description of the operation.

Basic VirtualFig GD&T Apps Coordination

Measurement between elements



Basic measurement elements



Measurement procedure example: Distance between centers of circles

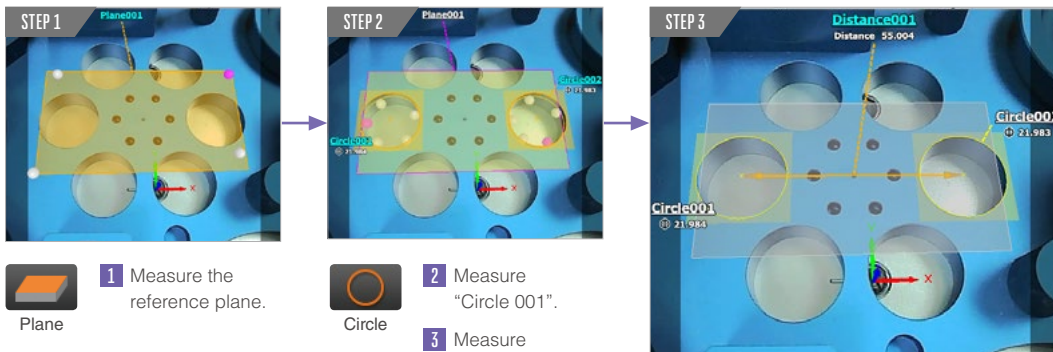

1 Measure the reference plane.

2 Measure "Circle 001".
3 Measure "Circle 002".

4 Select "Circle 001" and "Circle 002" in the distance menu to complete the process.

Coordinate measurement menu with a variety of options

Virtual figures

This menu is used to create virtual elements such as intersect lines and points. Measurement can then be performed based on these created elements.

[Measurement Example] Creating virtual intersect lines and intersections

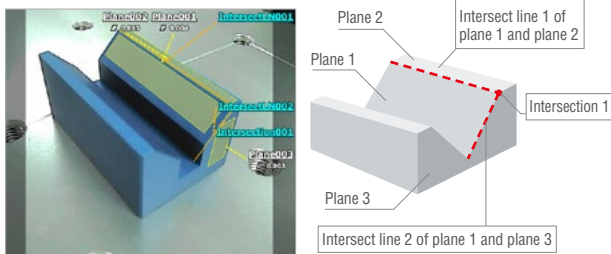

Create a "virtual intersect line" at the intersection of the planes or create a "virtual intersection" at the intersection of the intersect lines.

Basic	VirtualFig	GD&T	Apps	Coordination
Point				
Midpoint	Tangent point	Intersection	Perpendicular intersect	
Line				
Center line	Tangent line	Intersect line	Projection line	
Rotation line	Median plane	Parallel plane	Intersect circle	
Numerical input				
Plane 123	Line 123	Point 123	Circle 123	
Element specification				
Plane	Line	Point	Circle	

GD&T

GD&T includes measurements based on form, orientation, and location.

[Measurement Example] Measurement of Cylindricity and Concentricity - Cylinder

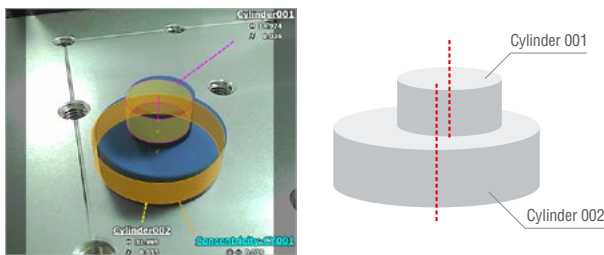

Using at least six measurement points, users can perform cylinder measurements. Because the cylinder includes an axis, concentricity between shafts and the angle related to other elements can also be obtained.

Basic	VirtualFig	GD&T	Apps	Coordination
Form				
Flatness	Roundness	Straightness	Cylindricity	
Orientation				
Parallelism	Perpendicularity	Angularity		
Location				
Position	Concentricity - Circle	Concentricity - Cylinder	Symmetry	

Enhanced coordinate configuration

Setting the X, Y, and Z axes as a reference within the measurement target allows for creation of a coordinate similar to any illustrations.

[Measurement Example] Specified Coordinate

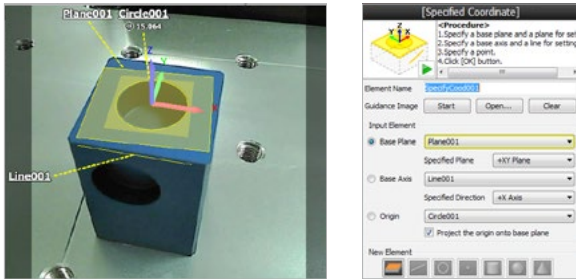

Specified coordinates can be easily set by simply selecting the base plane, base axis, and the origin from the pull-down menu or from within the image.

Basic	VirtualFig	GD&T	Apps	Coordination
NEW				
Simple Coordinate	Simple Coordinate - Cylinder			
Type A Coordinate	Type B Coordinate	Specified Coordinate		
CHANGE				
Base Plane Settings	Fit Axis to Point	Fit Axis to Line	Rotate Axis	
Fix Axis to Offset Point Correction	Set Origin	Reset Coordinate		
WORK ADJUST				
Work Adjust				

Particular Measurement Element/Useful Functions

Torus profile measurement

Torus profile measurement is a measuring element that measures a donut shape. This element provides such measurements as center diameter, inner diameter, outer diameter, and cross-sectional diameter.

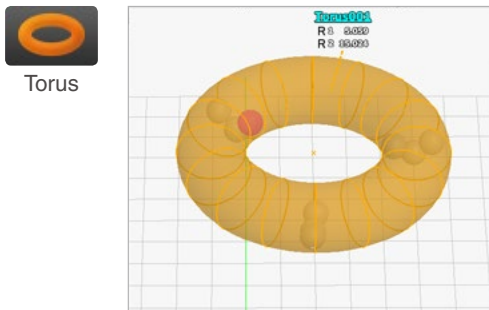

Deviation display

The XM Series displays the orientation and size of distortions through the direction and length of the arrows.

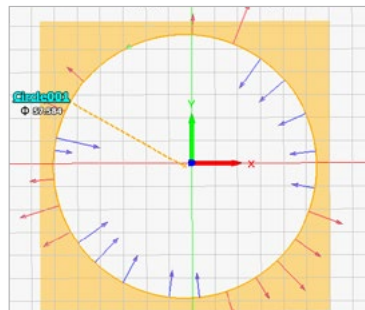

Wide variety of auxiliary functions that can be utilized instantly at the worksite

Run mode makes repeated measurement easy

Simply hold the probe against the target and watch the screen

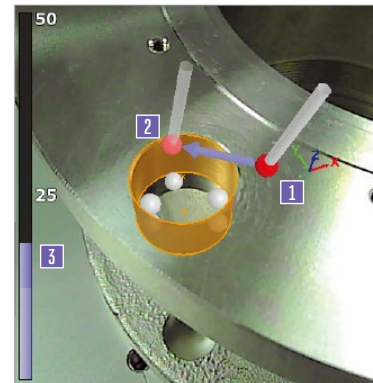

- 1** Current position
Shows the position of the tip of the probe being held.
- 2** Measurement point
Flashes to show the next measurement point.
- 3** Distance indicator
Displays the distance between the measurement point and the probe tip.

Tolerance judgment screen following measurement

Entering tolerances for each item in advance allows users to obtain pass/fail judgments for the measurement results. The date and duration of measurements will also be recorded and saved automatically.



Statistical analysis function for summarizing data

Following run mode, measurement results will be saved to the controller's hard disk drive automatically. Saved data can then be extracted for use with various statistic analyses.

Verification of statistics values

Key statistics values, such as the pass/fail count, max. value, min. value, average, σ , 3σ , 6σ , and Cpk, for selected measurement items can be calculated automatically and displayed.

Item	Item Name	Result
<input checked="" type="checkbox"/>	Circle Diameter (mm)	30
<input checked="" type="checkbox"/>	Included Measurement(s)	0
<input checked="" type="checkbox"/>	OK Number(s)	30
<input checked="" type="checkbox"/>	NG Number(s)	0
<input checked="" type="checkbox"/>	NG Rate	0.00%
<input checked="" type="checkbox"/>	Design Value	22.000
<input checked="" type="checkbox"/>	Upper Tolerance	22.100
<input checked="" type="checkbox"/>	Lower Tolerance	21.900
<input checked="" type="checkbox"/>	Maximum Value	22.012
<input checked="" type="checkbox"/>	Minimum Value	21.996
<input checked="" type="checkbox"/>	Average Value	22.004
<input checked="" type="checkbox"/>	Range (Max. - Min.)	0.016
<input checked="" type="checkbox"/>	St	0.00362
<input checked="" type="checkbox"/>	3 σ	0.01086
<input checked="" type="checkbox"/>	6 σ	0.02172
<input checked="" type="checkbox"/>	CP	1.66700
<input checked="" type="checkbox"/>	Cpk	0.77012

Trend graph

With the XM Series, the trends for selected measurement items can be viewed in a graph. This allows for visualization of such trends as increased variation, upward/downward trending measurements, and periodic fluctuation.

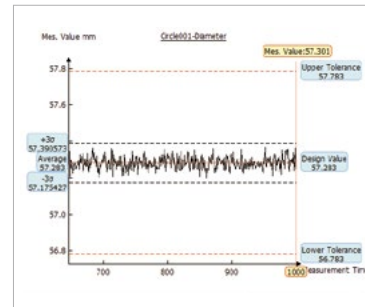

Histogram

The variations for each selected measurement item can be viewed in a graph. The graph, which shows the range of measurements as the horizontal axis and the frequency as the vertical axis, allows users to see whether the measurements are centering on any values in particular and how the measurements vary.

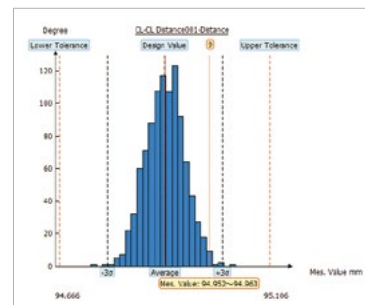

Definitive performance with a reliable support system

Traceability system diagram

The reference step gauge used for inspection and calibration has been calibrated by a DAkkS accredited company for a traceability system that meets international standards.

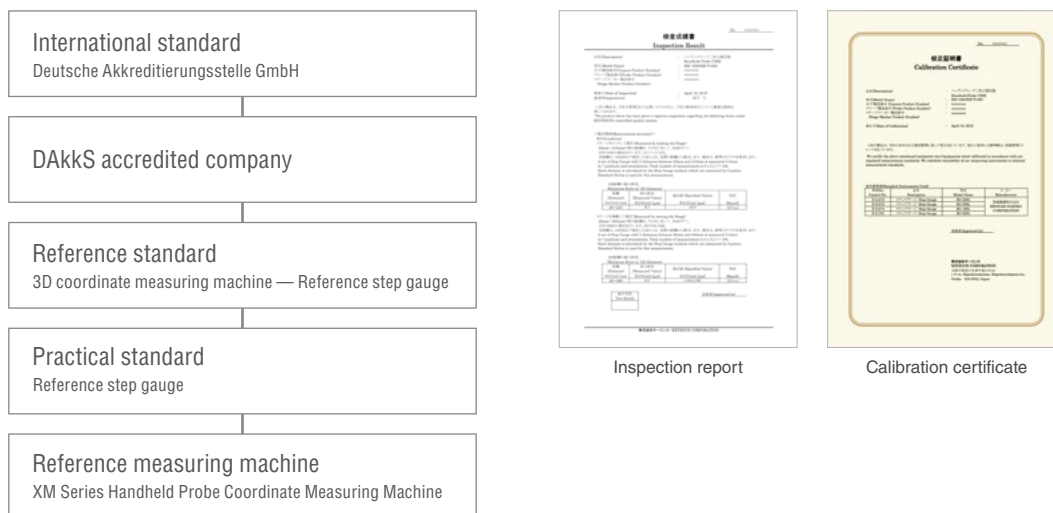

Post-delivery follow-up

Assistance with delivered goods

After the machine arrives, dedicated KEYENCE staff will provide instructions on handling and basic concepts.

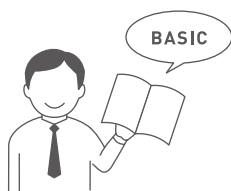

Self-teaching Kit

Users can continue to check their level of understanding even after the training using the "Self-teaching Kit" included with the product.



Phone/e-mail support

Dedicated coordinate measuring machine staff are on-call at KEYENCE's sales office to respond to customer telephone and e-mail inquiries.



Simple “tilt” and “press” stylus calibration system

With the ball of the stylus tip fixed to the cone on the special tool, calibration can be performed just by pressing the measurement button in at least 13 different orientations. Calibration can be completed in as little as 18 seconds.



Easy calibration using the dedicated calibration jig

Calibration support

Regular calibration is as easy as placing the probe, camera, and stage marker in the dedicated case and sending the case to KEYENCE. While calibration is being performed, a replacement machine (probe, camera, and stage marker) will be provided free of charge.



Dedicated case

APPLICATION EXAMPLES

XYZ position of side holes

Measurement details

- 1 Set the coordinates with the center of Circle A as the point of origin and the straight line between the centers of Circle A and Circle B as the X axis.
- 2 Find the XYZ coordinate and the position of the center of Circle C.

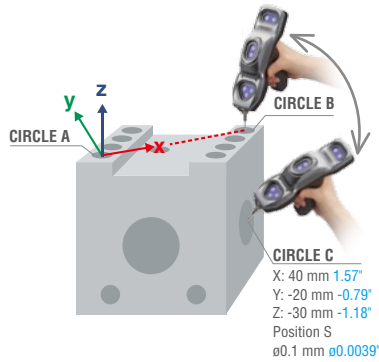

With the XM Series

Measurement can be performed easily only by touching the target from any angle even for elements with different orientations such as top holes and horizontal holes.

Cone angle and axis angle

Measurement details

- 1 Measure the tapered hole as a cone, and then measure the taper angle.
- 2 Measure the cylinder's axis and the angle of the plane.
- 3 Measure the diameter of the circle intersecting the cone and the plane.

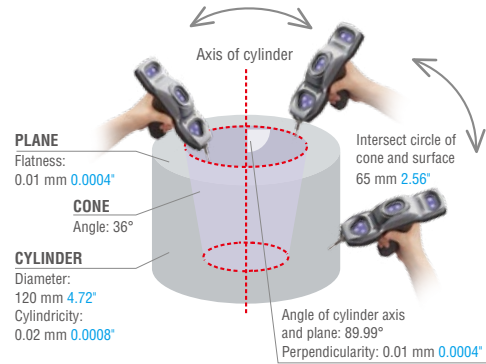

With the XM Series

Measurement of inclines and areas in deep holes is possible just by touching the target. Axis angle measurement for cylinders and cones is also simple.

Bending angles and measurement of virtual lines

Measurement details

- 1 Measure the bending angle of two planes.
- 2 Measure the distance from the intersect line to the circular hole.
- 3 Measure the distance from the intersect line to a point on rectangular slot.

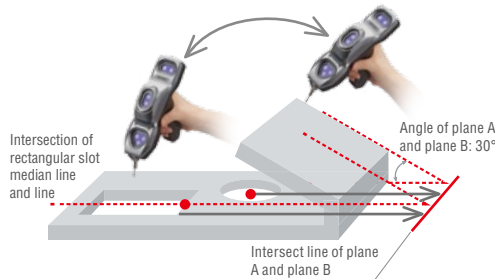

With the XM Series

Measurements not possible with worksite measuring tools can be easily performed using virtual points and lines.

PCD (pitch circle diameter) and angle allocation

Measurement details

- 1 Measure the PCD of the eight holes.
- 2 Measure the angle of adjacent holes using virtual lines.

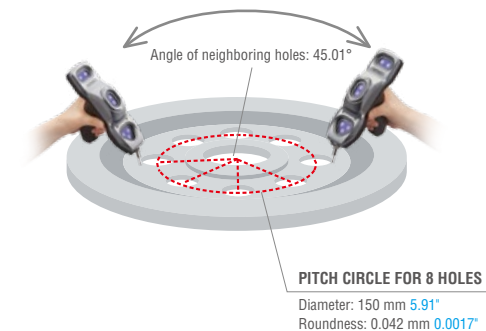

With the XM Series

Even users with no special knowledge of measurements can freely create auxiliary lines and circles as with a PC.

Measurement of side holes for large target with X θ stage

1 X θ stage fixed

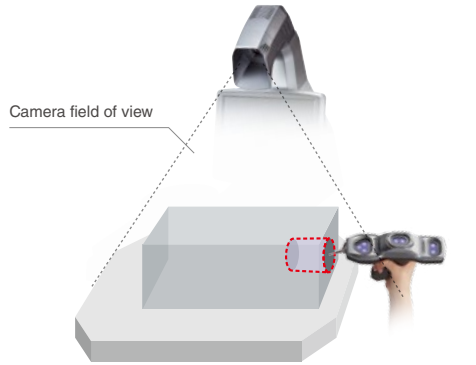

Measurement not possible

Because of the length, some probe markers fall outside the camera's field of view, making measurement impossible.

2 After the X θ stage has moved

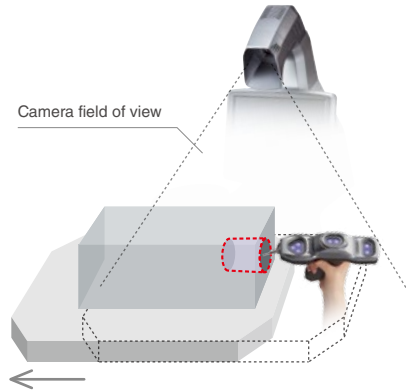

Measurement possible

Moving the X θ stage will bring the probe markers into the camera's field of view, allowing the user to perform measurement.

With the XM Series

With an X θ stage that can be moved up to 100 mm 3.94" to the right or left, users can move the stage to perform measurements even for targets that would normally be outside the camera's field of view when the probe is turned sideways. This is especially useful when measuring long targets.

Measurement of horizontal holes by rotating the X θ stage

1 X θ stage fixed

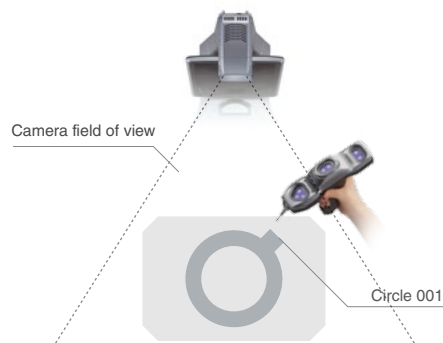

Measurement not possible

Some probe markers fall outside the camera's field of view, making measurement impossible.

2 After the X θ stage has rotated

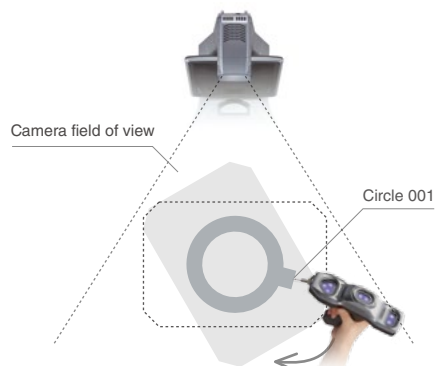

Measurement possible

Targets can be measured without changing the measurement target position by rotating the stage.

With the XM Series

By rotating the X θ stage, stable measurement is possible even in locations where the probe marker is not clearly within the camera's field of view.

SYSTEM CONFIGURATION

System with X θ stage



OPTIONS



XM-P1000
Probe



OP-87944
Standard stylus



OP-88083
ø2 mm ø0.08° stylus



OP-87947
Stylus
calibration jig



OP-87945
Console



OP-87949
Probe cable

Fixed-stage system

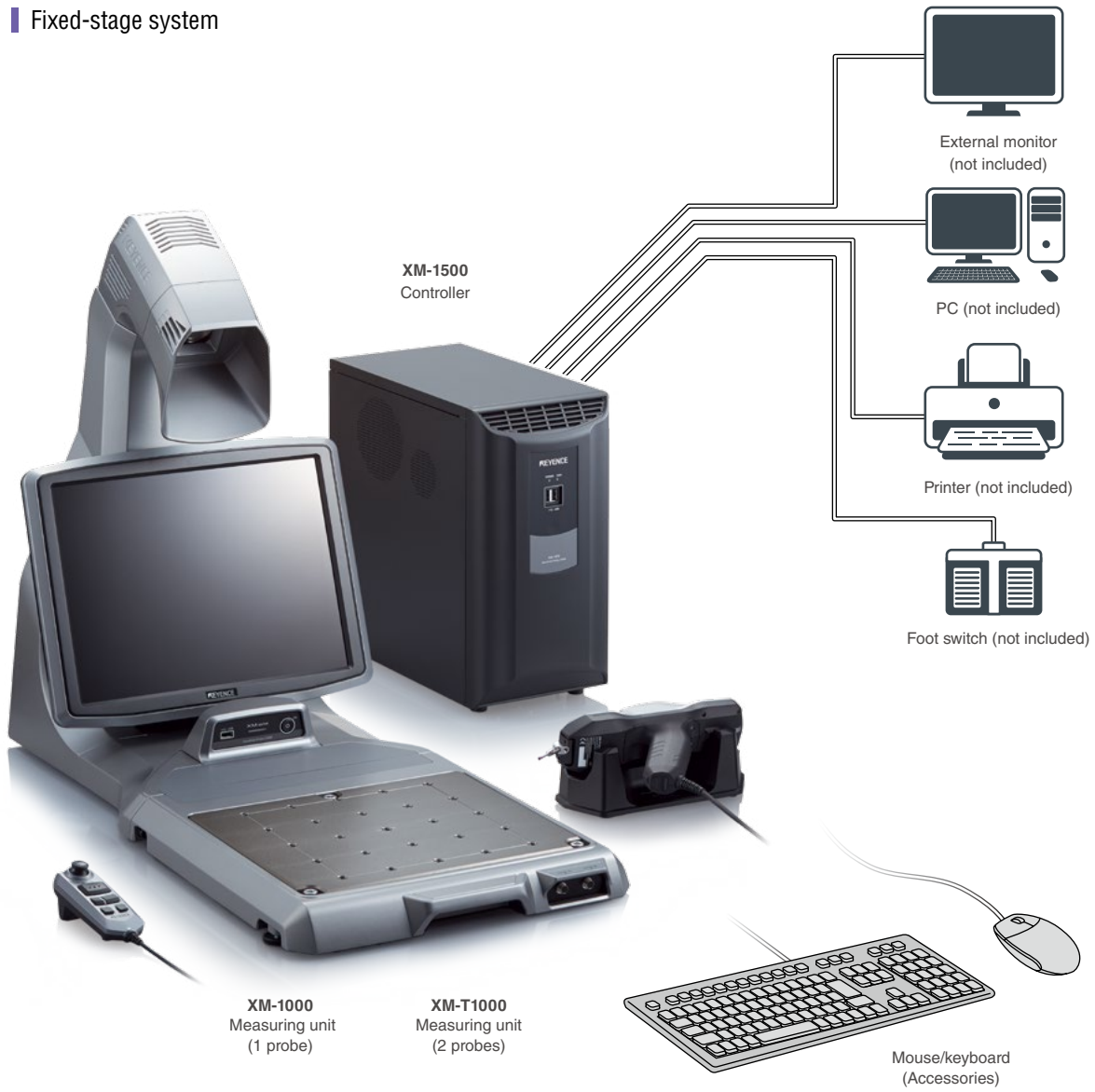

Interfaces



Front: USB port (2 ports)

- | | |
|-----------------------|-------------------------------------|
| 1. Serial output port | 6. USB port (4 ports on rear) |
| 2. DVI connector | 7. Main power switch |
| 3. MONITOR connector | 8. AC power input connector |
| 4. POWER connector | 9. Camera control port
(2 ports) |
| 5. LAN port | |



SPECIFICATIONS

Measuring unit

Model	Measuring unit	XM-1000	XM-T1000	XM-1200/M1200/S1200	XM-T1200/M1200/S1200
Camera	Image pickup device	4 megapixel CMOS image sensor			
	Wavelength at light receiving center	Near-infrared			
Measuring range		300 mm × 250 mm × 150 mm	11.81" × 9.84" × 5.91"	600 mm × 300 mm × 200 mm	23.62" × 11.81" × 7.87"
Min. display unit	Distance	1 μm			
	Angle	0.0001 degrees			
Measurement accuracy	Repeatability	Stage locked	±3 μm	±3 μm	
		Stage unlocked	-	±4 μm	
	Indication error	Stage locked	±8 μm* ¹	±8 μm* ¹	
		Stage unlocked	-	±(10 + L/100) μm* ²	
Stage	Withstand load	25 kg			
	X-axis movable range	-	-	±100 mm ±3.94"	
	Rotation range	-	-	±60°	
Probe	No. of probes	1	2	1	2
Stage marker	No. of markers	6			
	Marker light source	Near-infrared LED (870 nm)			
Probe connection port		2 inputs			
Console input		Dedicated console			
External remote input		Non-voltage input (with and without tangent point): 2 inputs			
Display	Built-in display	15" LCD monitor (1024 × 768)			
Interfaces	Communication (external communication)	USB 2.0 Series A: 3 ports			
Environmental resistance	Ambient temperature	+10 to +35°C 50 to 95°F			
	Ambient humidity	20 to 80% RH (no condensation)			
Power supply	Power supply voltage	Supplied from controller			
	Connector type	Dedicated connector			
Weight	Head	Approx. 28.2 kg (including camera and cable)		Approx. 39.6 kg (including camera and cable)	
	Console	Approx. 150 g (including cable)			

*1. In reference to ISO 10360-2 (within the range of 200 × 200 × 150 mm 7.87" × 7.87" × 5.91" at an operating ambient temperature of 23 ±1°C 73.4 ±1.8°F)

*2. In reference to ISO 10360-2 (within the range of 500 × 200 × 150 mm 19.69" × 7.87" × 5.91" at an operating ambient temperature of 23 ±1°C 73.4 ±1.8°F)

Controller

Model	Controller	XM-1500
HDD		320 GB
Interfaces	Measuring unit	Dedicated cable
	Communication (external communication)	RS-232C
		USB 2.0 Series A: 6 ports (Front: 2, rear: 4) LAN RJ45 (10BASE-T/100BASE-TX/1000BASE-T)
Display	External output	DVI-D
Power supply		100 to 240 VAC 50/60 Hz
Power consumption		250 VA max.
Weight		Approx. 7.7 kg
Environmental resistance	Ambient temperature	+10 to +35°C 50 to 95°F
	Ambient humidity	20 to 80% RH (no condensation)

Probe

Model	Probe	XM-P1000* ³
Marker	No. of markers	7
Housing material	Marker body	Quartz glass
	Probe housing	PBT plastic
Light source		Near-infrared LED (870 nm)
Applicable stylus		M4 (Commercially available styluses can be used)
Camera		Compact CMOS image sensor
Status LED		Green: Measurement possible Yellow: Probe camera image capture possible Red: Measurement impossible Off: Not selected
Weight		Approx. 370 g (including the cable)

*3. Included with XM-1000/XM-T1000/XM-1200 and XM-T1200 models.

Functions

Item	Subitem	Specifications
Measuring mode		Program mode/Run mode/Statistic analysis/Single measurement
No. of configurable elements		500 (excluding comment elements)
Maximum measurement points		200 points (per element)
Basic	Measurement between elements	Distance/Angle/Calculation
	Basic elements	Plane/Line/Point/Circle/Cylinder/Cone/Sphere
	Particular measurement element	Point - no correction/Ellipse/Single point circle/Stepped cylinder/Oval/Round slot/Corner arc/Chamfer line/Torus
Virtual figures	Point	Midpoint/Contact point/Intersection/Perpendicular/Numerical input/Element specification
	Line	Median line/Tangent line/Intersect line/Projection line/Rotation line/Numerical input/Element specification
	Plane	Median plane/Parallel plane/Numerical input/Element specification
	Circle	Intersect circle/Numerical input/Element specification
GD&T	Form	Flatness/Roundness/Straightness/Cylindricity
	Orientation	Parallelism/Perpendicularity/Angularity
	Location	Position/Concentricity/Coaxiality/Symmetry
Coordination	New	Simple coordinate/Type A coordinate/Type B coordinate/Specified coordinate
	Change	Base plane settings/Fit axis to point/Fit axis to line/Rotate axis/ Fix axis to offset point/Set origin/Reset coordinate
	Work adjust	Work adjust
Apps	Distance	Plane-to-point height/Plane-to-plane distance/Hole position
	Angle	Dihedral angle/Edge to edge angle
	Diameter	Diameter/Pitch circle diameter/Lower diameter/Upper diameter
	Position	Hole position/V groove
Batch settings		Batch tolerance settings/Batch settings for output/display items/Guidance image batch settings/List edit
No. of measurement macro settings		100
No. of probe settings		10
Average times of measurement		1/2/4/8/16
Check measurement position		Available
Print/file output		Inspection specifications/Single object report/Single object report (with guidance image)/Screen image/Graphic display image/ Probe camera image/CSV output
Import/Export		Move/Copy/Delete
Other		Comment/Other measurement results

Dimensions

Measuring unit

XM-1200/M1200/S1200
XM-T1200/M1200/S1200

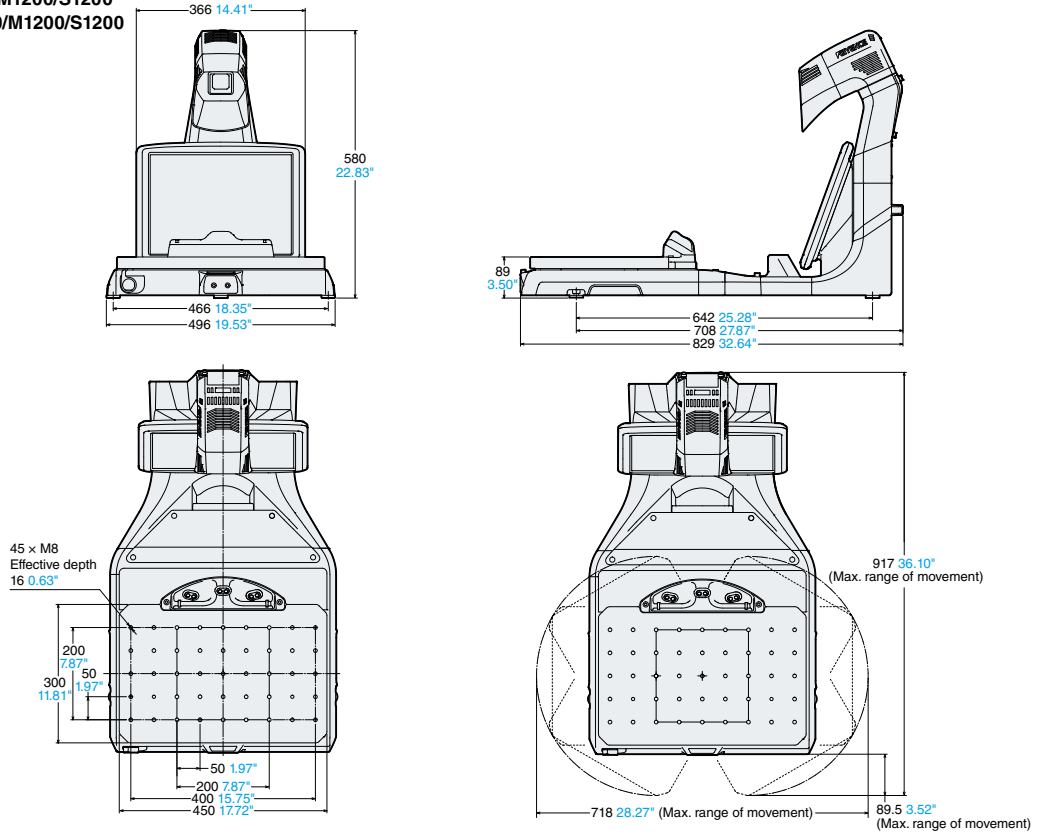

Measuring unit

XM-1000/XM-T1000

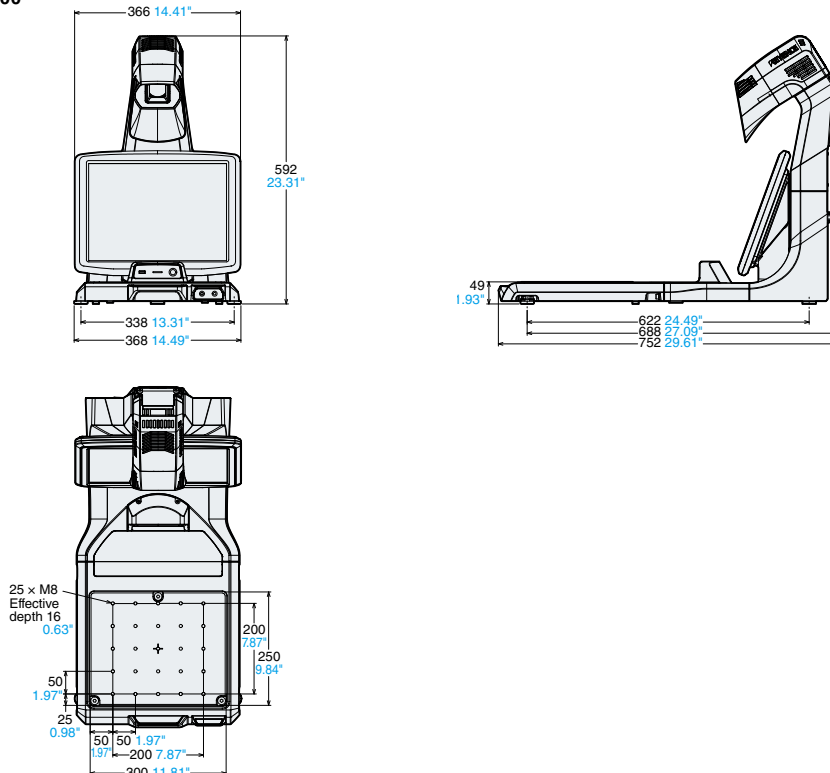

Probe

XM-P1000

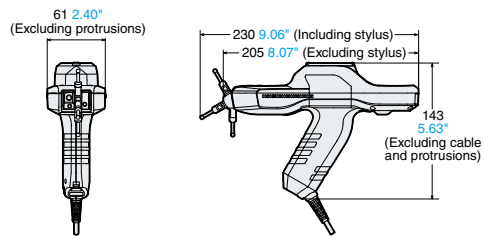

Console

OP-87945

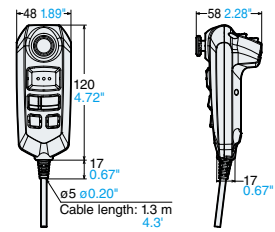

*When stylus OP-87944 is equipped.

Controller

XM-1500

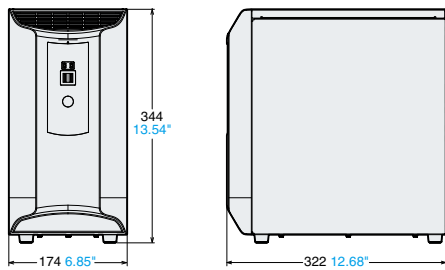

Stylus

OP-87944

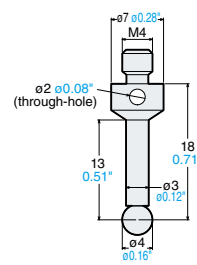

OP-88083

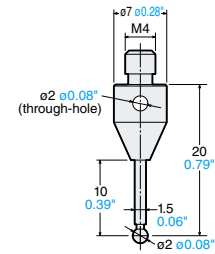

Target securing plate

OP-87946

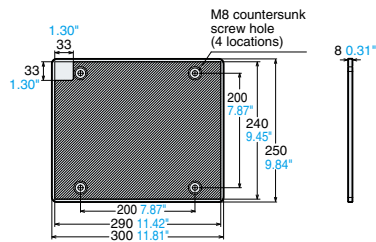

M6 base plate

OP-88080

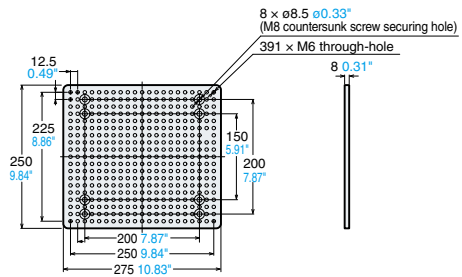



**CALL
TOLL
FREE**

TO CONTACT YOUR LOCAL OFFICE
1-888-KEYENCE
1 - 8 8 8 - 5 3 9 - 3 6 2 3

www.keyence.com



SAFETY INFORMATION

Please read the instruction manual carefully in order to safely operate any KEYENCE product.

CONTACT YOUR NEAREST OFFICE FOR RELEASE STATUS

KEYENCE CORPORATION OF AMERICA

Head Office 500 Park Boulevard, Suite 200, Itasca, IL 60143, U.S.A. **PHONE:** +1-201-930-0100 **FAX:** +1-855-539-0123 **E-mail:** keyence@keyence.com

AL Birmingham	CA San Jose	CO Denver	IL Chicago	MI Detroit	MO St. Louis	NC Raleigh	PA Philadelphia	TN Nashville	WI Milwaukee
AR Little Rock	CA Cupertino	FL Tampa	IN Indianapolis	MI Grand Rapids	NJ Elmwood Park	OH Cincinnati	PA Pittsburgh	TX Austin	
AZ Phoenix	CA Los Angeles	GA Atlanta	KY Louisville	MN Minneapolis	NY Rochester	OH Cleveland	SC Greenville	TX Dallas	
CA San Francisco	CA Irvine	IA Iowa	MA Boston	MO Kansas City	NC Charlotte	OR Portland	TN Knoxville	WA Seattle	

KEYENCE CANADA INC.

Head Office PHONE: +1-905-366-7655 FAX: +1-905-366-1122 E-mail: keyencecanada@keyence.com
Montreal PHONE: +1-514-694-4740 FAX: +1-514-694-3206 Windsor PHONE: +1-905-366-7655 FAX: +1-905-366-1122

KEYENCE MEXICO S.A. DE C.V.

PHONE: +52-55-8850-0100 FAX: +52-81-8220-9097
E-mail: keyencemexico@keyence.com

The information in this publication is based on KEYENCE's internal research/evaluation at the time of release and is subject to change without notice. Company and product names mentioned in this catalog are either trademarks or registered trademarks of their respective companies. The specifications are expressed in metric units. The English units have been converted from the original metric units.

Copyright (c) 2016 KEYENCE CORPORATION. All rights reserved.

KA1-1017

XM-KA-C2-US 1038-4[611D27]